

Design and Installation Manual for the Infiltrator ATL System in Ohio

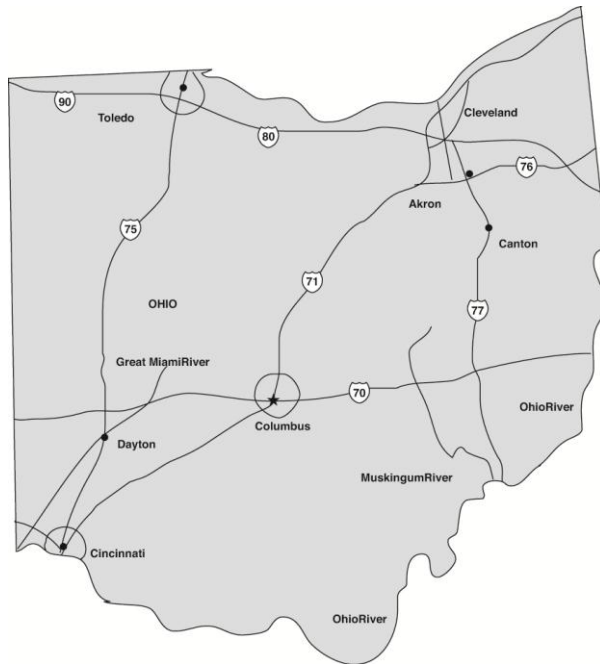

Infiltrator ATL System in Ohio	
INTRODUCTION	2
SYSTEM CONFIGURATIONS	4
SYSTEM DESIGN	9
SYSTEM DESIGN EXAMPLE	15
INFORMATION FOR SYSTEM OWNERS	22
INSTALLATION INSTRUCTIONS	24
WARRANTY	27

The purpose of this manual is to provide the minimum specifications for design and installation of the Infiltrator ATL (Advanced Treatment Leachfield) System in Ohio. All local ordinances, requirements, and procedures must be followed. Each revised version of this manual supersedes the previous version.

The configurations presented in this document are common designs and are provided for illustrative purposes. They are not intended to restrict the use of other configurations, which may be utilized provided the design conforms to the Ohio Administrative Code (OAC) 3701-29 and/or the Ohio Revised Code (ORC) 3718 as applicable.

For more detailed design and installation information, please contact Infiltrator Systems at 1-800-221-4436.



The Infiltrator ATL System

The Infiltrator ATL is a patent-pending, proprietary system consisting of six components. Upon entering the Infiltrator ATL, septic tank effluent progresses through each component as follows:

- 4-inch-diameter pipe
- Large-diameter synthetic aggregate;
- Coarse geotextile;
- Small-diameter synthetic aggregate;
- Fine geotextile; and
- 6-inch depth of specified system sand.

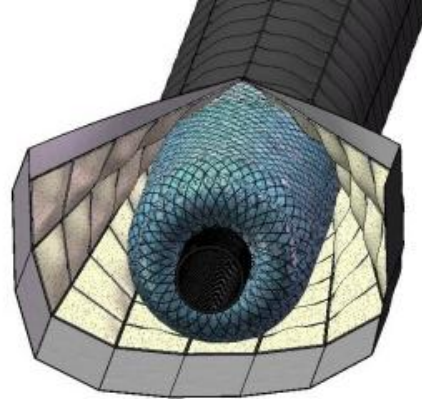

Infiltrator ATL System Definitions

“System sand” is the term used to describe the coarse sand material that surrounds the Infiltrator ATL System conduits. Acceptable material for use as system sand includes:

- material which meets ASTM C33 specifications; or
- material which meets Ohio Department of Transportation (DOT) Fine Aggregate Portland Cement Concrete sand (703.02) specifications.

In this document, the “system sand footprint” refers to the surface onto which the Infiltrator ATL System conduits are placed and the 12 inches of component sand around the conduits. The “basal area footprint” refers to the interface between the lowermost surface of the system sand and native soil. These definitions are portrayed in the diagram below.

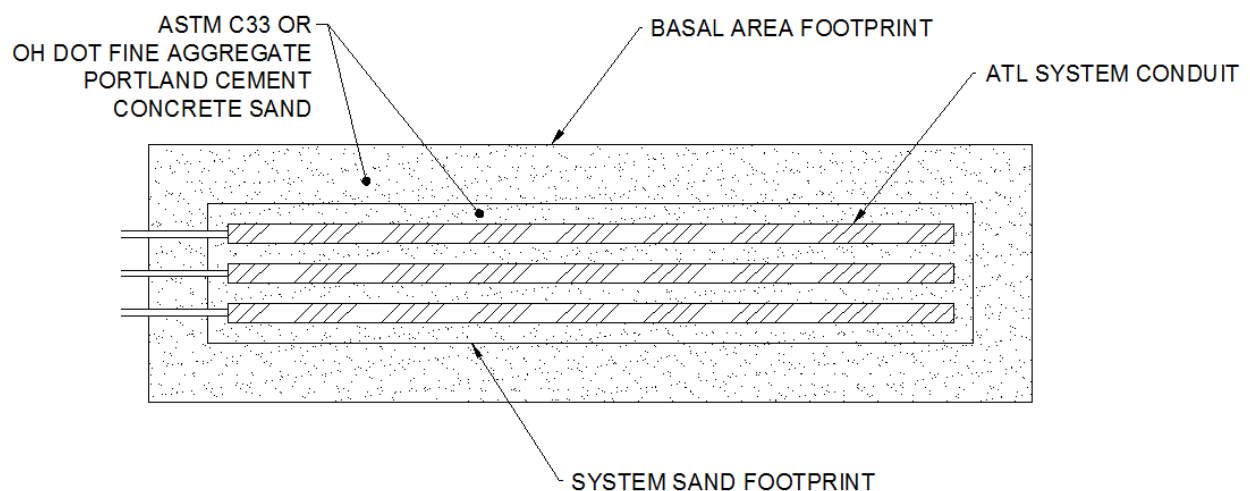

Information Specific to Use of the Infiltrator ATL System in Ohio

The Infiltrator ATL System is approved for use in the State of Ohio as a sewage treatment system by the Ohio Department of Health (ODH) in accordance with Ohio Revised Code (ORC) Section 3718.04. Testing in accordance with NSF/ANSI Standard 40 has determined that the Infiltrator ATL System is capable of treating domestic strength wastewater to Class I levels. The Infiltrator ATL System is also approved for use in the State of Ohio as a non-gravel, fines-free distribution system. These approvals allow for design and installation of the Infiltrator ATL System in the State of Ohio, in accordance with the specifications and instructions in this manual. If design, installation, operation, or maintenance specifications are not specifically addressed in this manual, relevant requirements in Ohio Administrative Code (OAC) 3701-29 and/or the Ohio Revised Code (ORC) 3718 shall be applicable.

System Configurations

The Infiltrator ATL System can be designed for use on level and sloped sites, in elevated and in-ground applications. Examples are shown in the following pages.

The following minimum system sand dimensions are required for all Infiltrator ATL System configurations:

- 6 inches below the ATL conduit rows;
- 12 inches between adjacent Infiltrator ATL conduit rows;
- 12 inches beside (outside) any Infiltrator ATL conduit row with no adjacent conduit row;
- 12 inches extending beyond both ends of the Infiltrator ATL conduit rows; and
- 3-foot minimum downslope sand extension on sites with slopes greater than 5%.

The Infiltrator ATL System is approved for use in Ohio with a minimum of 6 inches of cover material (after settling). There is no minimum requirement for system sand on top of the ATL conduit rows.

Additional requirements apply depending upon site-specific slope conditions and the position of the Infiltrator ATL System relative to ground surface elevation, as outlined in below.

Site-Specific Slope Conditions	Requirements
Level (less than or equal to 5% slope)	<ul style="list-style-type: none">• No minimum sand extension requirements
Sloped (5 to 33% slope)	<ul style="list-style-type: none">• 25% maximum allowable system slope• 3-foot minimum downslope system sand extension

Infiltrator ATL requirements based on site-specific conditions

Separation Distances

Horizontal separation distances shall comply with all state and local regulations, and are measured from the edge of the system sand, exclusive of any sand extensions.

Vertical separation distances shall comply with all state and local regulations, and are measured from the bottom of the 6" basal system sand layer.

System plans shall specify the elevations of the bottom of each of the ATL conduit rows, to ensure that the system installation meets minimum vertical separation from any limiting condition.

Level In-ground Systems

Cross-Section View

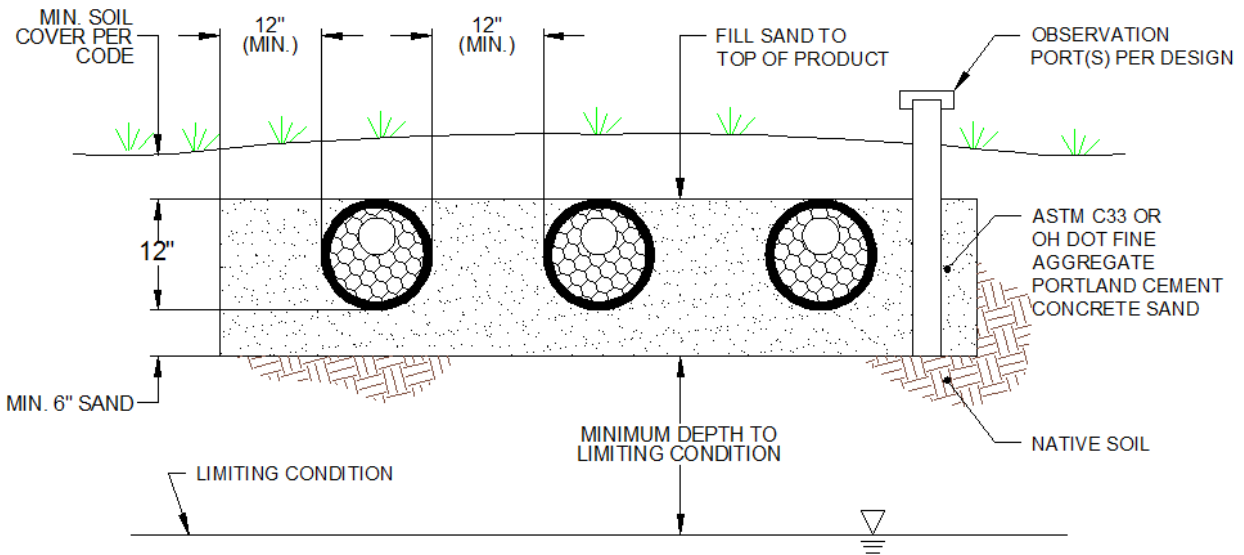

Plan View

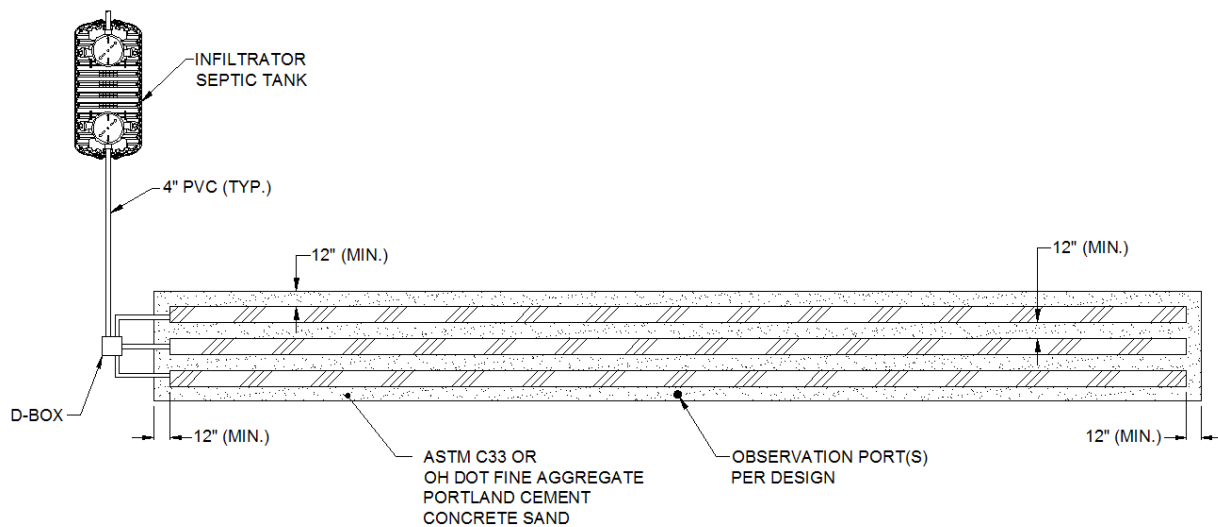

NOTES:

1. Number and length of conduits per design.
2. Venting is not required but is optional at the discretion of the designer.
3. Pumping is not required unless gravity flow cannot be achieved.
4. Observation ports are required.
5. The ATL System is intended for use in non-traffic applications.

Sloped In-ground Systems

Cross-Section View

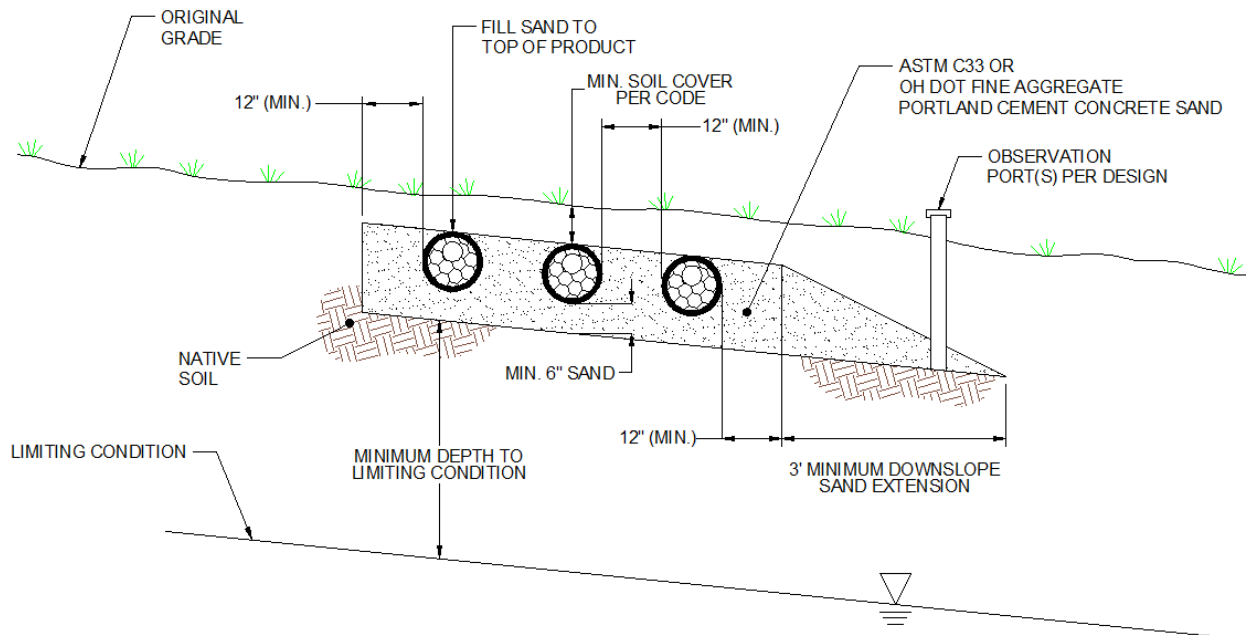

Plan View

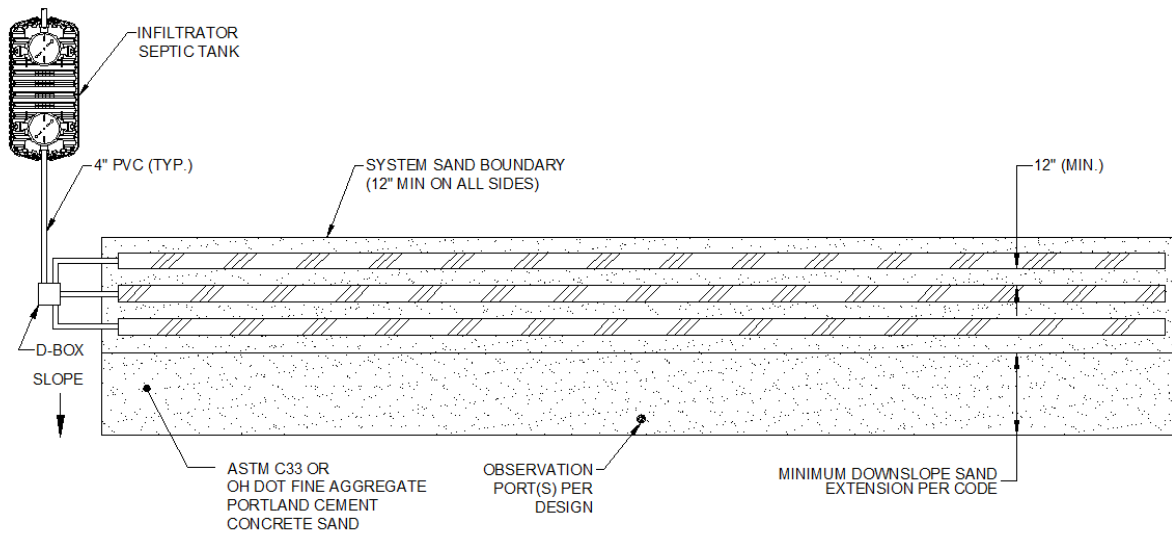

NOTES:

1. Number and length of conduits per design.
2. Venting is not required but is optional at the discretion of the designer.
3. Pumping is not required unless gravity flow cannot be achieved.
4. Observation ports are required.
5. The ATL System is intended for use in non-traffic applications.

Level Elevated Systems

Cross-Section View

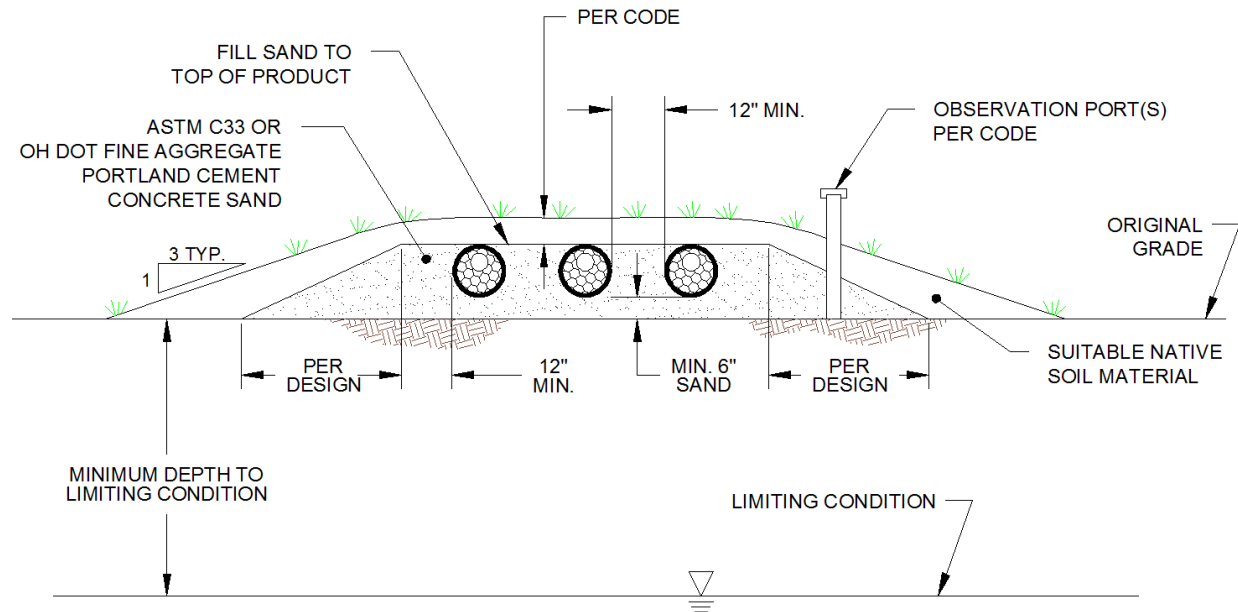

Plan View

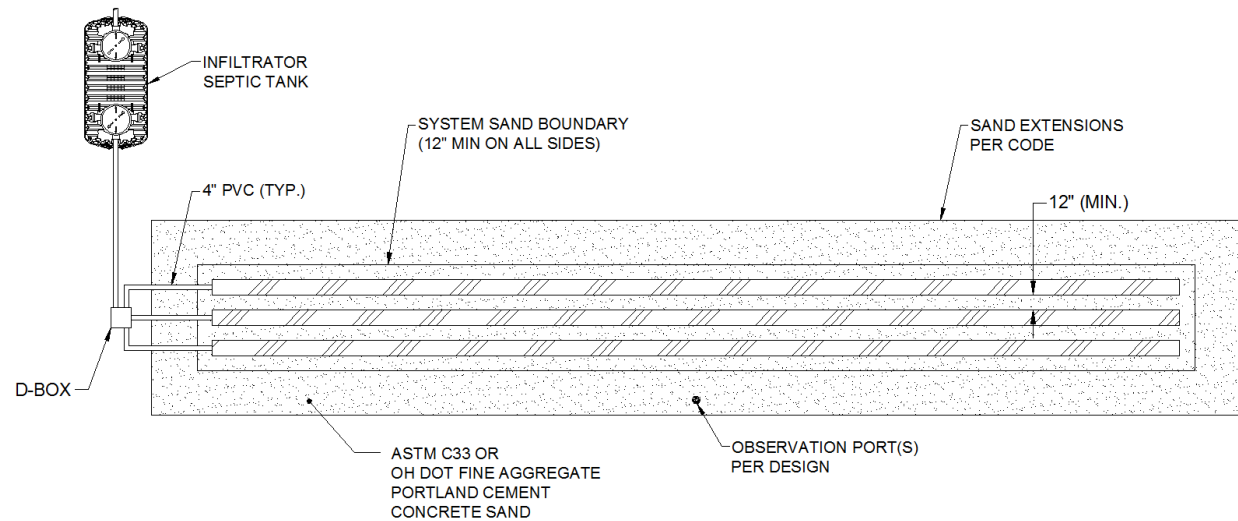

NOTES:

1. An ATL System is elevated if any part of the system, including soil cover, is above existing grade.
2. Number and length of conduits per design.
3. Venting is not required but is optional at the discretion of the designer.
4. Pumping is not required unless gravity flow cannot be achieved.
5. If the infiltrative surface of the infiltrator ATL System bed must be elevated to achieve minimum vertical separation requirements, the area between the original grade and the Infiltrator ATL system sand shall be comprised of additional system sand.
6. Observation ports are required.
7. The ATL System is intended for use in non-traffic applications.

Sloped Elevated Systems

Cross-Section View

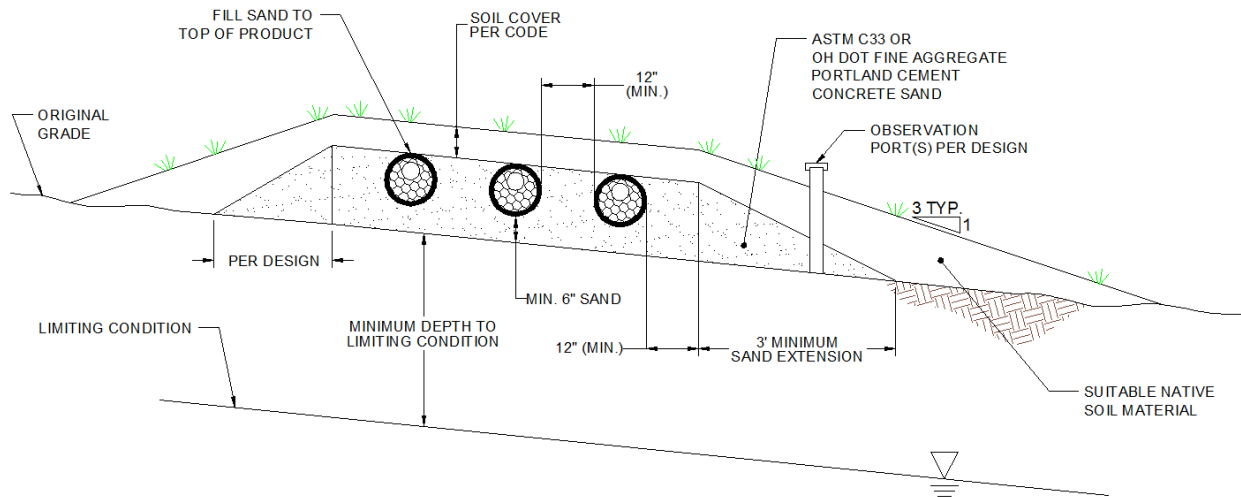

Plan View

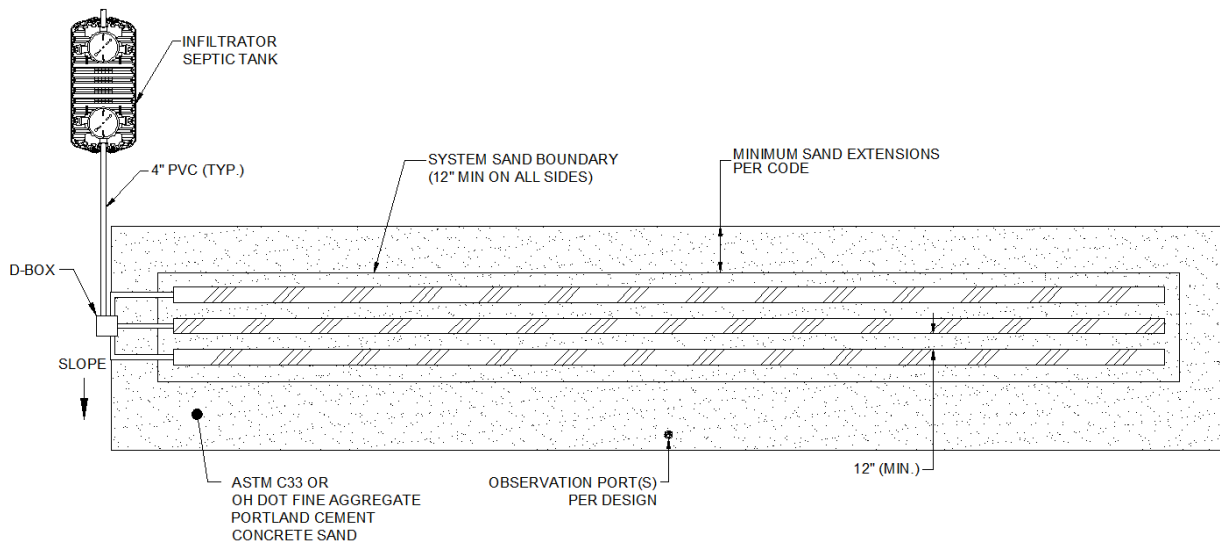

NOTES:

1. An ATL System is elevated if any part of the system, including soil cover, is above existing grade.
2. Number and length of conduits per design.
3. Venting is not required but is optional at the discretion of the designer.
4. Pumping is not required unless gravity flow cannot be achieved.
5. If the infiltrative surface of the Infiltrator ATL System bed must be elevated to achieve minimum vertical separation requirements, the area between the original grade and the Infiltrator ATL system sand shall be comprised of additional system sand.
6. Observation ports are required.
7. The ATL System is intended for use in non-traffic applications.

System Design

Designing the Infiltrator ATL System in Ohio is a seven step process.

1. Determine the minimum Infiltrator ATL conduit length
2. Determine the appropriate hydraulic linear loading rate
3. Calculate the minimum conduit length per conduit row
4. Design the system sand configuration
5. Determine the appropriate soil infiltration loading rate
6. Determine the minimum basal area
7. Make area and length adjustments, as necessary

Step 1: Determine the minimum Infiltrator ATL conduit length

The minimum length of Infiltrator ATL conduit per bedroom is 70 feet. Determine the minimum length of Infiltrator ATL conduit from Table 1, based on the number of bedrooms.

Number of Bedrooms	Design Flow (gpd)	Minimum Infiltrator ATL Length (ft)
2	240	140
3	360	210
4	480	280
5	600	350
Each Additional	120	70

Table 1: Minimum required Infiltrator ATL conduit length

SYSTEM DESIGN

Step 2: Determine the appropriate hydraulic linear loading rate

After performing a site and soil evaluation, use Table 2 to determine the appropriate hydraulic linear loading rate.

Soil Characteristics			Hydraulic Linear Loading Rate (gpd/ft)								
			Slope 0-4%			Slope 5-9%			Slope >10%		
Texture	Structure		Infiltrative Distance (inches)			Infiltrative Distance (inches)			Infiltrative Distance (inches)		
	Shape	Grade	8-12	12-24	24-48	8-12	12-24	24-48	8-12	12-24	24-48
COS, S, LCOS, LS	--	OSG	4.0	5.0	6.0	5.0	6.0	7.0	6.0	7.0	8.0
FS, VFS, LFS, LVFS	--	OSG	3.5	4.5	5.5	4.0	5.0	6.0	5.0	6.0	7.0
CSL, SL	--	OM	3.0	3.5	4.0	3.6	4.1	4.6	5.0	6.0	7.0
	PL	1	3.0	3.5	4.0	3.6	4.1	4.6	4.0	5.0	6.0
		2, 3	-	-	-	-	-	-	-	-	-
	PR/BK/GR	1	3.5	4.5	5.5	4.0	5.0	6.0	5.0	6.0	7.0
		2, 3	3.5	4.5	5.5	4.0	5.0	6.0	5.0	6.0	7.0
FSL, VFSL	--	OM	2.0	2.3	2.6	2.4	2.7	3.0	2.7	3.2	3.7
	PL	1, 2, 3	-	-	-	-	-	-	-	-	-
	PR/BK/GR	1	3.0	3.5	4.0	3.3	3.8	4.3	3.6	4.1	4.6
		2, 3	3.3	3.8	4.3	3.6	4.1	4.6	3.9	4.4	4.9
	L	--	OM	2.0	2.3	2.6	2.4	2.7	3.0	2.7	3.2
PL		1, 2, 3	-	-	-	-	-	-	-	-	-
PR/BK/GR		1	3.0	3.5	4.0	3.3	3.8	4.3	3.6	4.1	4.6
		2, 3	3.3	3.8	4.3	3.6	4.1	4.6	3.9	4.4	4.9
SIL		--	OM	2.0	2.5	3.0	2.2	2.7	3.2	2.4	2.9
	PL	1, 2, 3	-	-	-	-	-	-	-	-	-
	PR/BK/GR	1	2.4	2.7	3.0	2.7	3.0	3.3	3.0	3.5	4.0
		2, 3	2.7	3.0	3.3	3.0	3.5	4.0	3.3	3.8	4.3
	SCL, CL, SICL	--	OM	-	-	-	-	-	-	-	-
PL		1, 2, 3	-	-	-	-	-	-	-	-	-
PR/BK/GR		1	2.0	2.5	3.0	2.2	2.7	3.2	2.4	2.9	3.4
		2, 3	2.4	2.9	3.4	2.7	3.0	3.3	3.0	3.5	4.0
SC, C, SIC		--	OM	-	-	-	-	-	-	-	-
	PL	1, 2, 3	-	-	-	-	-	-	-	-	-
	PR/BK/GR	1	-	-	-	-	-	-	-	-	-
		2, 3	2.0	2.5	3.0	2.2	2.7	3.2	2.4	2.9	3.4

Table 2: Hydraulic linear loading rates¹

¹ Adapted from Tyler, E.J., "Hydraulic Wastewater Loading Rates to Soil". *Proceedings of the 9th International Symposium on Individual and Small Community Sewage Systems*. ASAE. St. Joseph, MI. p. 80-86.

Step 3: Calculate the minimum conduit length per conduit row

Determine the minimum required conduit length per conduit row using the hydraulic linear loading rate (determined in Step 2) and Table 3.

Hydraulic Linear Loading Rate (gpd/sf)	Minimum Conduit Length per Conduit Row (lf)			
	3 Bedrooms	4 Bedrooms	5 Bedrooms	Each Add'l Bedroom
8.0	45	60	75	15
7.0	51	69	86	17
6.0	60	80	100	20
5.5	65	87	109	22
5.0	72	96	120	24
4.9	73	98	122	24
4.6	78	104	130	26
4.5	80	107	133	27
4.4	82	109	136	27
4.3	84	112	140	28
4.1	88	117	146	29
4.0	90	120	150	30
3.9	92	123	154	31
3.8	95	126	158	32
3.7	97	130	162	32
3.6	100	133	167	33
3.5	103	137	171	34
3.4	106	141	176	35
3.3	109	145	182	36
3.2	113	150	188	38
3.0	120	160	200	40
2.9	124	166	207	41
2.7	133	178	222	44
2.6	138	185	231	46
2.5	144	192	240	48
2.4	150	200	250	50
2.3	157	209	261	52
2.2	164	218	273	55
2.0	180	240	300	60

Table 3: Minimum conduit length per conduit row

NOTE: Infiltrator ATL conduit rows may be fed at multiple locations, given the minimum conduit length determined by Table 3 remains on contour, to meet linear loading requirements.

Step 4: Design the system sand configuration

Use Table 4 to determine the minimum system sand footprint using the minimum total length of Infiltrator ATL conduit as determined from Table 1 and the number of rows into which the total length of conduit will be divided. The system should be designed as long and narrow as site conditions allow; therefore, the number of rows of Infiltrator ATL conduit should be minimized, while ensuring the minimum conduit length per conduit row requirement is met (as calculated in Step 3).

Minimum Length of ATL Conduit (ft)	Minimum System Sand Dimensions and Area							
	1 Conduit Row		2 Conduit Rows		3 Conduit Rows		4 Conduit Rows	
	Dimensions (W x L)	Area (sf)	Dimensions (W x L)	Area (sf)	Dimensions (W x L)	Area (sf)	Dimensions (W x L)	Area (sf)
140	3' x 142'	426	5' x 72'	360	7' x 49'	343	9' x 37'	333
210	3' x 212'	636	5' x 107'	535	7' x 72'	504	9' x 55'	495
280	3' x 282'	846	5' x 142'	710	7' x 96'	672	9' x 72'	648
350	3' x 352'	1,056	5' x 177'	885	7' x 119'	833	9' x 88'	792

Table 4: Minimum system sand dimensions and area

NOTES:

1. The Infiltrator ATL System conduit rows must be extended to within one foot of each end of the bed. ATL conduits may be cut to meet these minimum requirements or extended to the nearest ten-foot length for ease of installation.
2. Minimum width of the system sand footprint, as determined in Step 4, shall not be decreased when making adjustments as detailed in Step 7 (below), even if the minimum width combined with linear loading requirements results in total square footage of sand area greater than the calculated minimum.

Step 5: Determine the appropriate soil infiltration loading rate

Using the soil characteristics determined through the site and soil evaluation, use Table 5 to determine the appropriate soil infiltration loading rate.

Soil Characteristics			Soil Infiltration Loading Rate (gpd/ft ²)
Texture	Structure		
	Shape	Grade	
COS, S, LCOS, LS	--	OSG	1.6
FS, VFS, LFS, LVFS	--	OSG	1.0
CSL, SL	--	OM	0.6
	PL	1	0.5
		2, 3	-
	PR/BK/GR	1	0.7
		2, 3	1.0
FSL, VFSL	--	OM	0.5
	PL	1, 2, 3	-
		1	0.6
	PR/BK/GR	2, 3	0.8
L		--	OM
	PL	1, 2, 3	-
		1	0.6
	PR/BK/GR	2, 3	0.8
SIL		--	OM
	PL	1, 2, 3	-
		1	0.6
	PR/BK/GR	2, 3	0.8
SCL, CL, SICL		--	OM
	PL	1, 2, 3	-
		1	0.3
	PR/BK/GR	2, 3	0.6
SC, C, SIC		--	OM
	PL	1, 2, 3	-
		1	-
	PR/BK/GR	2, 3	0.3

Table 5: Soil infiltration loading rates²

² Adapted from Tyler, E.J., "Hydraulic Wastewater Loading Rates to Soil". *Proceedings of the 9th International Symposium on Individual and Small Community Sewage Systems*. ASAE. St. Joseph, MI. p. 80-86.

Step 6: Determine the minimum basal area

Determine the minimum required basal area using the soil infiltration loading rate (determined in Step 5) and Table 6.

Soil Loading Rate (gpd/sf)	Minimum Basal Area (sf)			
	3 Bedrooms	4 Bedrooms	5 Bedrooms	Each Add'l Bedroom
1.6	225	300	375	75
1.0	360	480	600	120
0.8	450	600	750	150
0.7	514	686	857	171
0.6	600	800	1,000	200
0.5	720	960	1,200	240
0.3	1,200	1,600	2,000	400
0.2	1,800	2,400	3,000	600

Table 6: Minimum basal area

Step 7: Make area and length adjustments, as necessary

The minimum areas determined in Steps 4 and 6 cannot be reduced. These areas must be maintained to ensure adequate area for placement of the Infiltrator ATL System conduits and infiltration of treated effluent into the native soil.

Area adjustments are necessary as follows:

- If the minimum basal area determined in Step 6 is smaller than the area of the system sand footprint determined in Step 4, no adjustments are necessary.
- If the minimum basal area determined in Step 6 is larger than the area of the system sand footprint determined in Step 4, the system sand footprint must be increased.

In most instances, the width of the system sand component is extended to increase the system sand footprint. When making adjustments to the width of the system sand footprint:

- In level system applications, additional width shall be evenly divided on each side of the Infiltrator ATL System; or
- In sloped system applications, additional width shall be entirely placed on the downslope side of the Infiltrator ATL System. The minimum sand extension for sites with slopes greater than 5% is 3 feet.

Minimum width of the system sand footprint as determined in Step 4 shall not be decreased when making adjustments as detailed in this step, even if the minimum width combined with linear loading requirements results in total square footage of sand area greater than the calculated minimum.

Make adjustments to the bed length to meet the minimum required conduit length as calculated in Step 3.

Sample System Design Calculations

The following sample system design calculations are intended to illustrate the methodology for designing an Infiltrator ATL System. The sample system design calculations are provided in the step-by-step format described above.

Sample system specifications:

- 4-bedroom home
- 3% slope on site
- Infiltration distance of 30 inches
- Grade 1, granular loam soil

Step 1: Determine the minimum Infiltrator ATL conduit length

The minimum length of Infiltrator ATL conduit per bedroom is 70 feet. Determine the minimum length of Infiltrator ATL conduit from Table 1 based on the number of bedrooms.

Number of Bedrooms	Design Flow (gpd)	Minimum Infiltrator ATL Length (ft)
2	240	140
3	360	210
4	480	280
5	600	350
Each Additional	120	70

Table 1: Minimum required Infiltrator ATL conduit length

SYSTEM DESIGN EXAMPLE

Step 2: Determine the appropriate hydraulic linear loading rate

Based on the sample system specifications and Table 2, the hydraulic linear loading rate would be 4.0 gpd/ft.

Soil Characteristics			Hydraulic Linear Loading Rate (gpd/ft)								
			Slope 0-4%			Slope 5-9%			Slope >10%		
Texture	Structure		Infiltrative Distance (inches)			Infiltrative Distance (inches)			Infiltrative Distance (inches)		
	Shape	Grade	8-12	12-24	24-48	8-12	12-24	24-48	8-12	12-24	24-48
COS, S, LCOS, LS	--	OSG	4.0	5.0	6.0	5.0	6.0	7.0	6.0	7.0	8.0
FS, VFS, LFS, LVFS	--	OSG	3.5	4.5	5.5	4.0	5.0	6.0	5.0	6.0	7.0
CSL, SL	--	OM	3.0	3.5	4.0	3.6	4.1	4.6	5.0	6.0	7.0
	PL	1	3.0	3.5	4.0	3.6	4.1	4.6	4.0	5.0	6.0
		2, 3	-	-	-	-	-	-	-	-	-
	PR/BK/GR	1	3.5	4.5	5.5	4.0	5.0	6.0	5.0	6.0	7.0
2, 3		3.5	4.5	5.5	4.0	5.0	6.0	5.0	6.0	7.0	
FSL, VFSL	--	OM	2.0	2.3	2.6	2.4	2.7	3.0	2.7	3.2	3.7
	PL	1, 2, 3	-	-	-	-	-	-	-	-	-
		PR/BK/GR	1	3.0	3.5	4.0	3.3	3.8	4.3	3.6	4.1
	2, 3		3.3	3.8	4.3	3.6	4.1	4.6	3.9	4.4	4.9
L	--	OM	2.0	2.3	2.6	2.4	2.7	3.0	2.7	3.2	3.7
	PL	1, 2, 3	-	-	-	-	-	-	-	-	-
		PR/BK/GR	1	3.0	3.5	4.0	3.3	3.8	4.3	3.6	4.1
	2, 3		3.3	3.8	4.3	3.6	4.1	4.6	3.9	4.4	4.9
SIL	--	OM	2.0	2.5	3.0	2.2	2.7	3.2	2.4	2.9	3.4
	PL	1, 2, 3	-	-	-	-	-	-	-	-	-
		PR/BK/GR	1	2.4	2.7	3.0	2.7	3.0	3.3	3.0	3.5
	2, 3		2.7	3.0	3.3	3.0	3.5	4.0	3.3	3.8	4.3
SCL, CL, SICL	--	OM	-	-	-	-	-	-	-	-	-
	PL	1, 2, 3	-	-	-	-	-	-	-	-	-
		PR/BK/GR	1	2.0	2.5	3.0	2.2	2.7	3.2	2.4	2.9
	2, 3		2.4	2.9	3.4	2.7	3.0	3.3	3.0	3.5	4.0
SC, C, SIC	--	OM	-	-	-	-	-	-	-	-	-
	PL	1, 2, 3	-	-	-	-	-	-	-	-	-
		PR/BK/GR	1	-	-	-	-	-	-	-	-
	2, 3		2.0	2.5	3.0	2.2	2.7	3.2	2.4	2.9	3.4

Table 2: Hydraulic linear loading rates

SYSTEM DESIGN EXAMPLE

Step 3: Calculate the minimum conduit length per conduit row

Referencing Table 3 and using the hydraulic linear loading rate from Step 2, the minimum conduit length per conduit row for a 4 bedroom home is 120 ft.

Hydraulic Linear Loading Rate (gpd/sf)	Minimum Conduit Length per Conduit Row (lf)			
	3 Bedrooms	4 Bedrooms	5 Bedrooms	Each Add'l Bedroom
8.0	45	60	75	15
7.0	51	69	86	17
6.0	60	80	100	20
5.5	65	87	109	22
5.0	72	95	120	24
4.9	73	98	122	24
4.6	78	104	130	26
4.5	80	107	133	27
4.4	82	109	136	27
4.3	84	112	140	28
4.1	88	117	146	29
4.0	90	120	150	30
3.9	92	123	154	31
3.8	95	126	158	32
3.7	97	130	162	32
3.6	100	133	167	33
3.5	103	137	171	34
3.4	106	141	176	35
3.3	109	145	182	36
3.2	113	150	188	38
3.0	120	160	200	40
2.9	124	166	207	41
2.7	133	178	222	44
2.6	138	185	231	46
2.5	144	192	240	48
2.4	150	200	250	50
2.3	157	209	261	52
2.2	164	218	273	55
2.0	180	240	300	60

Table 3: Minimum conduit length per conduit row

NOTE: Infiltrator ATL conduit rows may be fed at multiple locations, given the minimum conduit length determined by Table 3 remains on contour, to meet linear loading requirements.

SYSTEM DESIGN EXAMPLE

Step 4: Design the system sand configuration

Per Table 4, a 240-foot conduit length can be arranged in the following configurations:

- 1 conduit wide – 3 ft wide x 282 ft long (846 sf)
- 2 conduits wide – 5 ft wide x 142 ft long (710 sf)
- 3 conduits wide – 7 ft wide x 96 ft long (672 sf)
- 4 conduits wide – 9 ft wide x 72 ft long (648 sf)

Since the minimum system length was determined to be 120 ft in Step 3, either the one- or two-row configurations must be used to meet the hydraulic loading capacity of the site. The 2-row configuration is chosen for this example.

Minimum Length of ATL Conduit (ft)	Minimum System Sand Dimensions and Area							
	1 Conduit Row		2 Conduit Rows		3 Conduit Rows		4 Conduit Rows	
	Dimensions (W x L)	Area (sf)	Dimensions (W x L)	Area (sf)	Dimensions (W x L)	Area (sf)	Dimensions (W x L)	Area (sf)
140	3' x 142'	426	5' x 72'	360	7' x 49'	343	9' x 37'	333
210	3' x 212'	636	5' x 107'	535	7' x 72'	504	9' x 55'	495
280	3' x 282'	846	5' x 142'	710	7' x 96'	672	9' x 72'	648
350	3' x 352'	1,056	5' x 177'	885	7' x 119'	833	9' x 88'	792

Table 4: Minimum system sand dimensions and area

NOTE: The Infiltrator ATL System conduit rows must be extended to within one foot of each end of the bed. ATL conduits may be cut to meet these minimum requirements or extended to the nearest ten-foot length for ease of installation.

SYSTEM DESIGN EXAMPLE

Step 5: Determine the appropriate soil infiltration loading rate

Based on the sample system specifications and Table 5, the soil infiltration loading rate would be 0.6 gpd/ft².

Soil Characteristics			Soil Infiltration Loading Rate (gpd/ft ²)
Texture	Structure		
	Shape	Grade	
COS, S, LCOS, LS	--	OSG	1.6
FS, VFS, LFS, LVFS	--	OSG	1.0
CSL, SL	--	OM	0.6
	PL	1	0.5
		2, 3	-
	PR/BK/GR	1	0.7
		2, 3	1.0
FSL, VFSL	--	OM	0.5
	PL	1, 2, 3	-
	PR/BK/GR	1	0.6
		2, 3	0.8
L	--	OM	0.5
	PL	1, 2, 3	-
	PR/BK/GR	1	0.6
		2, 3	0.8
SIL	--	OM	0.2
	PL	1, 2, 3	-
	PR/BK/GR	1	0.6
		2, 3	0.8
SCL, CL, SICL	--	OM	-
	PL	1, 2, 3	-
	PR/BK/GR	1	0.3
		2, 3	0.6
SC, C, SIC	--	OM	-
	PL	1, 2, 3	-
	PR/BK/GR	1	-
		2, 3	0.3

Table 5: Soil infiltration loading rates

SYSTEM DESIGN EXAMPLE

Step 6: Determine the minimum basal area

Referencing Table 6 and using the soil infiltration loading rate of 0.6 gpd/ft² determined in Step 5, the minimum basal area is 800 sf.

Soil Loading Rate (gpd/sf)	Minimum Basal Area (sf)			
	3 Bedrooms	4 Bedrooms	5 Bedrooms	Each Add'l Bedroom
1.6	225	300	375	75
1.0	360	480	600	120
0.8	450	600	750	150
0.7	514	686	857	171
0.6	600	800	1,000	200
0.5	720	960	1,200	240
0.4	900	1,200	1,500	300
0.3	1,200	1,600	2,000	400
0.2	1,800	2,400	3,000	600

Table 6: Minimum basal area

Step 7: Make area and length adjustments, as necessary.

After establishing system configuration in Step 4, the need for area adjustments is assessed in Step 7. This evaluation includes comparing the size of the basal area (Step 6, Table 6) to the area of the system sand footprint (Step 4, Table 4) to determine if the system sand footprint must be widened to meet the required minimum basal area.

- Soil loading rate of 0.6 gpd/sf and minimum basal area 800 sf

As determined in Step 4, the minimum length of the system is 142 ft and the minimum width of the system is 5 ft, for a system sand footprint of 710 sf. Since the 800-sf minimum basal area is larger than the 710-sf system sand footprint, an adjustment to the size of the system sand footprint is necessary.

Divide the basal area by the length of the system sand:

$$800 \text{ ft}^2 \div 142 \text{ ft} = 5.64 \text{ ft}$$

Subtract the original system sand footprint width from the above adjusted system sand footprint width:

$$5.64 \text{ ft} - 5 \text{ ft} = 0.64 \text{ ft}$$

SYSTEM DESIGN EXAMPLE

Divide the additional required width by 2 to determine the sand extension to add to each side of the system sand footprint width:

$$0.64 \text{ ft} \div 2 = 0.32 \text{ ft}$$

The system sand width must be widened by 0.64 feet, by adding 0.32 feet of system sand to each side, resulting in a total width of 5.64 ft:

$$5.64 \text{ ft} \times 142 \text{ ft} = 800 \text{ ft}^2$$

NOTE: *When making adjustments as detailed in this step, minimum width of the system sand footprint shall not be decreased, even if the minimum width combined with linear loading requirements results in total square footage of sand area greater than the calculated minimum.*

Information for System Owners

Basic rules of onsite sewage treatment system use and care apply to the ATL System. System owners shall operate the system in accordance with Ohio Administrative Code (OAC) 3701-29 and/or the Ohio Revised Code (ORC) 3718, and the following:

System Use and Abuse

Your Infiltrator ATL System is intended for use with residential-strength wastewater within the design daily flow volume. To ensure long-term function of your system:

- Keep daily wastewater flow within design parameters
 - Do not connect the rainwater management system to the Infiltrator ATL System.
 - Direct water from the rainwater management system away from the Infiltrator ATL System.
- Introduce only normal residential wastewater into the system
 - Solvents, paint, pharmaceuticals, aggressive cleaning products, and non-biodegradable items should not enter the Infiltrator ATL system.
 - Solids, such as but not limited to, cigarette butts, diapers, feminine hygiene products, cat litter, and paper towels should not be introduced into the Infiltrator ATL system.
- Maintain leak-free household plumbing fixtures, such as faucets and toilets.
- Do not utilize a garbage grinder.
- The ATL System is intended for use in non-traffic applications. Therefore,
 - Do not allow heavy equipment or vehicles to drive over the system;
 - Install protections to prevent exposure of the system to inadvertent heavy equipment or vehicular loading; and
 - Do not build structures on top of the system

Operation and Maintenance

Your Infiltrator ATL System has no specific operating instructions. Proper use of the system as noted above is the primary operating concern.

Maintenance of the Infiltrator ATL System includes the following:

- If the septic tank has an effluent filter, it should be cleaned by a maintenance provider on an annual basis.
- The septic tank should be pumped on a regular basis and, if concrete, checked for leaks and cracks. The interval for septic tank pumping varies depending upon use. Check with a qualified onsite wastewater system professional or your local health department for the appropriate pumping interval.
- If present, the alarm system should be tested annually by the homeowner to ensure that it is functional if one is included in the system.

If at any time you have concerns about the use, operation, or maintenance of your Infiltrator ATL System, contact the Infiltrator Systems, Inc. Technical Department at 1-800-221-4436.

System Start-up

There are no specific requirements for placing the Infiltrator ATL System into service. If the system has an alarm, the property owner should, after system use has been initiated, test the alarm to ensure it is functional.

Intermittent Use

The Infiltrator ATL System is designed for intermittent use, and requires no special attention if it is to be placed out of use for extended periods of time.

Trouble Shooting

In the event that any of the following indicators arise, contact a qualified onsite wastewater system professional.

- Wastewater back-up into the dwelling
- Persistent septic odor
- Unusually wet area atop and/or around the system
- “Ponding” of effluent on the lawn
- “Breakout” of effluent along the side of a slope or other landscape feature

Repair

A qualified onsite wastewater system professional shall be contacted when there are indications of malfunction with the Infiltrator ATL System. When visiting the site, the qualified onsite wastewater system professional should, at a minimum, do the following:

- Assess the present condition of the Infiltrator ATL System and the surrounding area
- Research the history of use, including:
 - water volume use
 - contaminants
- Evaluate the site for groundwater intrusion
- Inspect the septic tank
- Inspect the Infiltrator ATL System conduit lines
- Check faucet and toilet function

Upon completion of the site visit, the qualified onsite wastewater system professional should contact the Infiltrator Systems, Inc. Technical Department with his or her report.

Before You Begin

These installation instructions are for the Infiltrator ATL System in Ohio. Infiltrator ATL Systems may only be installed according to this manual, the latest versions of Ohio Administrative Code (OAC) 3701-29 and the Ohio Revised Code (ORC) 3718, and local health department requirements.

If unsure of the installation requirements for a site, contact your local health department. If unsure of the use of the Infiltrator ATL System, contact Infiltrator Systems, Inc. The soil and site evaluation and the design of the onsite system must be reviewed, and a construction permit obtained from the local health department before installation.

Materials and Equipment Needed

- | | |
|--|--|
| <input type="checkbox"/> Infiltrator ATL System conduits | <input type="checkbox"/> Shovel and rake |
| <input type="checkbox"/> System sand | <input type="checkbox"/> 4-inch inspection port and cap |
| <input type="checkbox"/> PVC pipe and couplings | <input type="checkbox"/> Endcaps |
| <input type="checkbox"/> Backhoe | <input type="checkbox"/> Infiltrator ATL System conduit internal pipe couplers |
| <input type="checkbox"/> Laser, transit or level | <input type="checkbox"/> Tape measure |

Common practices shall apply to the installation of the Infiltrator ATL System. These include, but are not limited to:

- avoid soil compaction on the infiltrative surface area, including all areas downslope of a sloped system;
- use a tracked vehicle for material installation;
- avoid installation during wet periods; and
- install the Infiltrator ATL System conduit and system sand on the same day that the system footprint is excavated/exposed.

Excavating and Preparing the Site

NOTE: *The Infiltrator ATL System may not be installed during periods when the soil is sufficiently wet to exceed its plastic limit, as this causes machinery to smear the soil.*

1. Stake out the locations of tank(s), pipes, conduit rows, and corners of the system to be tilled/excavated, per engineer design. Set the elevations as shown on the approved plan. [Note: The proper elevation of solid PVC header line going to each Infiltrator ATL conduit row should be determined to ensure compliance with the required system bottom depth as shown on the approved permit. This height may vary dependent on system height and configuration used.]

2. Install sedimentation and erosion control measures.

NOTE: *The installation of temporary drainage swales/berms (surface diversions) may be necessary to protect the site during rainfall events.*

3. For subsurface system applications:
 - (a) Excavate the bed area or till the ground as per the design.

INSTALLATION INSTRUCTIONS

- (b) Rake the bed bottom and sides (when applicable) if smearing has occurred during excavation. Remove large stones and protruding roots.

NOTE: *Smearing does not occur in sandy soils, so raking is not necessary. In fine textured soils (silts and clays), avoid walking on the excavation bottom to prevent compaction and loss of soil structure.*

4. For elevated system applications:
 - (a) All vegetation shall be cut close to the ground and removed from the site. Stumps, roots, sod, topsoil and boulders shall not be removed.
 - (b) Installation shall take place from the upslope side, and contact with the basal infiltrative surface area and downslope side of the system should be avoided, where applicable.
 - (c) The basal infiltrative surface of the system shall be prepared according to site conditions to maximize the infiltrative capacity of the soil surface.
 - (d) Any scarification of the basal infiltrative surface shall be conducted along the contour, where applicable.
 - (e) Sand may be incorporated into the basal infiltrative area during the preparation process, and may be placed along the entire basal infiltrative surface area to prevent damage from precipitation or foot traffic.
5. Verify that the bed area is at the proper slope from side-to-side and from end-to-end using a level, transit, or laser.

Installing the System

1. Install the system sand basal layer over the entire Infiltrator ATL System area as per design. System sand should be leveled and stabilized prior to introduction of the Infiltrator ATL conduit. Installer should retain records verifying that system sand meets ASTM C-33 or Ohio Department of Transportation (DOT) Fine Aggregate Portland Cement Concrete sand (703.02) requirements.
2. Remove plastic stretch wrap from Infiltrator ATL conduits.
3. Place Infiltrator ATL conduits on the surface of the system sand in the configuration shown on the system design. Using the provided 4-inch-diameter internal pipe couplings, connect the Infiltrator ATL conduits end-to-end to create rows of the required length.
4. Infiltrator ATL conduit shall be installed level. A laser level or transit is recommended to ensure proper alignment.
5. Infiltrator ATL conduit rows shall be:
 - installed level end-to-end;
 - be installed parallel to any contours; and
 - be separated by a minimum of 12 inches of system sand.
6. Install a cap on the end of each Infiltrator ATL conduit row that is not connected with piping.
7. Once the Infiltrator ATL conduit is placed on the surface of the system sand and distribution piping is connected to the conduits per design, additional system sand shall be ladled between and to the top of each of the Infiltrator ATL conduit rows. System sand shall also be installed on each side and

INSTALLATION INSTRUCTIONS

at each end of the backfilled Infiltrator ATL conduit rows, per the design. This additional system sand shall be stabilized.

Installing Observation/Monitoring Ports

Observation or monitoring ports are required in each ATL System design.

1. Cut a 6-inch PVC pipe to the desired length, ensuring the pipe will extend a minimum of 6 inches above final grade.
2. Drill a minimum of ten ¼" to ½" holes within ½ to 6 inches of the bottom of the pipe, and wrap the bottom end of the pipe in filter fabric..
3. Install the monitoring pipe at the appropriate location, based on site conditions, and ensure the bottom of the pipe is at the bottom of the system sand footprint (at the system sand/native soil interface).
4. Install a removable, water-tight, secure cover cap.

Covering the System

NOTE: Before backfilling, the system shall be inspected and approved by a representative of the local health department, as required by OAC 3701-29 and/or ORC 3718 and in compliance with local ordinances and procedures.

1. The ATL System was tested, and is approved for use in Ohio, with a minimum of 6 inches of cover material after settling.
2. Material placed around the system sand and atop the Infiltrator ATL conduit may be additional system sand or material which meets OAC 3701-29 and/or ORC 3718 requirements. However, the final 6 inches placed atop or adjacent to the Infiltrator ATL System shall be comprised of material that will sustain plant growth.
3. Backfill the bed by pushing material over the Infiltrator ATL System. It is best to mound several extra inches of soil over the finish grade to allow for settling. This also ensures that runoff is diverted away from the system. Keep a minimum of 12 inches of consolidated cover over the Infiltrator ATL conduits before driving over the system.
4. After the system is covered, the site should be seeded or sodded to prevent erosion. The maximum depth of cover over the Infiltrator ATL system is 4 feet.

NOTE: If the system is for new home construction, it is important to leave marking stakes along the boundary of the system. This will notify contractors of the system location so they will not cross it with equipment or vehicles.

WARRANTY

INFILTRATOR SYSTEMS, INC., ("Infiltrator")
ATL SYSTEM STANDARD LIMITED WARRANTY

- (a) The structural integrity of the Infiltrator ATL System conduits manufactured by Infiltrator (collectively referred to as "Units"), when installed and operated in a leachfield of an onsite septic system in accordance with Infiltrator's installation instructions, is warranted to the original purchaser ("Holder") against defective materials and workmanship for one year from the date upon which a septic permit is issued for the septic system containing the Units; provided, however, that if a septic permit is not required for the septic system by applicable law, the one (1) year warranty period will begin upon the date that installation of the septic system commences. In order to exercise its warranty rights, Holder must notify Infiltrator in writing at its corporate headquarters in Old Saybrook, Connecticut within fifteen (15) days of the alleged defect. Infiltrator will supply replacement Units for those Units determined by Infiltrator to be defective and covered by this Limited Warranty. Infiltrator's liability specifically excludes the cost of removal and/or installation of the Units.
- (b) THE LIMITED WARRANTY AND REMEDIES IN SUBPARAGRAPH (a) ARE EXCLUSIVE. THERE ARE NO OTHER WARRANTIES WITH RESPECT TO THE UNITS, INCLUDING NO IMPLIED WARRANTIES OF MERCHANTABILITY OR FITNESS FOR A PARTICULAR PURPOSE.
- (c) This Limited Warranty shall be void if any part of the ATL System components is manufactured by anyone other than Infiltrator. The Limited Warranty does not extend to incidental, consequential, special or indirect damages. Infiltrator shall not be liable for penalties or liquidated damages, including loss of production and profits, labor and materials, overhead costs, or other losses or expenses incurred by the Holder or any third party. Specifically excluded from Limited Warranty coverage are damage to the Units due to ordinary wear and tear, alteration, accident, misuse, abuse or neglect of the Units; the Units being subjected to vehicle traffic or other conditions which are not permitted by the installation instructions; failure to maintain the minimum ground covers set forth in the installation instructions; the placement of improper materials into the system containing the Units; failure of the Units or the septic system due to improper siting or improper sizing, excessive water usage, improper grease disposal, or improper operation; or any other event not caused by Infiltrator. This Limited Warranty shall be void if the Holder fails to comply with all of the terms set forth in this Limited Warranty.

Further, in no event shall Infiltrator be responsible for any loss or damage to the Holder, the Units, or any third party resulting from installation or shipment, or from any product liability claims of Holder or any third party. For this Limited Warranty to apply, the Units must be installed in accordance with all site conditions required by state and local codes; all other applicable laws; and Infiltrator's installation instructions.

- (d) No representative of Infiltrator has the authority to change this Limited Warranty in any manner whatsoever, or to extend this Limited Warranty. No warranty applies to any party other than the original Holder.

The above represents the standard Limited Warranty offered by Infiltrator. A limited number of states and counties have different warranty requirements. Any purchaser of Units should contact Infiltrator's corporate headquarters in Old Saybrook, Connecticut, prior to such purchase, to obtain a copy of the applicable warranty, and should carefully read that warranty prior to the purchase of Units.



INFILTRATOR®
systems inc.

P.O. Box 768 • Old Saybrook, CT 06475
800-221-4436

April 2014